

# Data Sheet for Precision Potentiometer

Singleturn Wirewound Potentiometer

Series RP19/20



The RP19/20 potentiometers in Ø22mm housings are suitable for applications where an accurate and compact sensor with a high electrically effective angle of rotation is required.

- Accurate wirewound potentiometer
- With or without mechanical end stop (320° / 360°)
- Very high electrically effective angle of rotation 355° ±5°
- Compact sensor with 12 mm installation depth
- With many options

The RP19/20 series of potentiometers (RP19 with mechanical end stop) is a multi-talented sensor that can be adapted to a wide range of applications and is often used as a feedback sensor in valve control systems. The sensor also offers good accuracy. The radial gold-plated connection pins are suitable for flat connectors (2.8 mm to DIN 46247 part 3).

Electrical Data	RP19	RP20
Effective electrical angle of rotation 1.)	320° ±5°	355° ±5°
Total resistance 1.)	10 Ohm..20 kOhm	
Resistance tolerance	±3% (±1%)	
Independent linearity (best straight line) 1.)	±0.5% (±0.35% $R \leq 1kOhm$ / ±0.25% $R > 1kOhm$ )	
Theoretical resolution 1.)	Depends on resistance value (see table below)	
Backlash (Hysteresis) 1.)	≤ 0.5°	
Rotational noise (ENR) 1.) (Method C)	100 Ohm	
Max. / recommended wiper current 1.)	35 mA / 2 µA	
Power rating @ 70°C (0W @ 105°C)	0.5 W	
Insulation Voltage 1.)	1000 VAC, 1min	
Insulation Resistance 1.)	1000 MOhm @ 1000 VDC	

Mechanical Data, Environmental Conditions, Miscellaneous	RP19	RP20
Mechanical angle of rotation 1.)	320° +10° with stop	360° without stop
Lifetime (90% el. eff. angle half sine) 2.)	1 Mio. rotations	
Max. operational speed	40 rev. / min.	
Bearing	Sleeve bearing	
Operational torque @ ambient temperature 1.) 2.)	5 Nmm	
End stop torque 1.) 2.)	60 Ncm	-
Operating temperature range	-20 °C up to +105 °C	
Storage temperature range	-55 °C up to +105 °C	
Protection grade (IEC 60529)	IP40	
Protection option D shaft sealing (IEC 60529)	IP65 optional	
Vibration (IEC 68-2-6, Test Fc)	15g 10Hz up to 2000Hz x 12h	
Shock (IEC 68-2-27, Test Ea)	49g @ 11 ms x 18	
Housing diameter	22 mm	
Housing depth	12 mm	
Shaft diameter	6 mm (optional 6.35 mm)	
Shaft type	Solid shaft	

# Data Sheet for Precision Potentiometer

Singleturn Wirewound Potentiometer

Series RP19/20

Mechanical Data, Environmental Conditions, Miscellaneous	RP19	RP20
Max. radial load	≤1 N	
Max. axial load	≤1 N	
Connection type	Gold plated soldering lugs	
Connection position	Radial	
Sensor mounting	Bushing	
Mass	20 g	
Fastening parts included in delivery	Nut, toothed washer	
Fastening torque mounting nut	150 Ncm	
Material shaft	Stainless steel	
Material housing	Reinforced fibreglass PA66	

1.) According IEC 60393

2.) Determined by climatic conditions according to IEC 68-1, para. 5.3.1 without load collectives

Please note: Max. permissible supply voltage <75 VDC respectively <50 VAC in addition the max. power rating must be observed

Number of wire turns / resolution									
Resistance value Ohm	50	100	200	500	1k	2k	5k	10k	20k
Number of wire turns	300	370	470	450	570	740	1000	1270	1670
Resolution in % (100% / number of turns)	0.333	0.27	0.213	0.222	0.1754	0.135	0.1	0.079	0.599

# Data Sheet for Precision Potentiometer

Singleturn Wirewound Potentiometer

Series RP19/20

Order code									
<b>Description</b>	Selection: <b>standard=black/bold</b> , possible <i>options=grey/italic</i>								
<b>Series:</b>	<b>RP</b>								
<b>Mechanical angle of rotation:</b>									
<b>Without stop</b>	<b>20</b>								
<b>With stop</b>	<b>19</b>								
<b>Resistance value / Option Tandem:</b>				<i>Tandem</i>					
<i>Option 10 Ohm</i>			<i>R10</i>	<i>/10</i>					
<i>Option 20 Ohm</i>			<i>R20</i>	<i>/20</i>					
<i>Option 50 Ohm</i>			<i>R50</i>	<i>/50</i>					
<i>Option 100 Ohm</i>			<i>R100</i>	<i>/100</i>					
<i>Option 200 Ohm</i>			<i>R200</i>	<i>/200</i>					
<i>Option 500 Ohm</i>			<i>R500</i>	<i>/500</i>					
<b>1 kOhm</b>			<b>R1k</b>	<b>/1K</b>					
<i>Option 2 kOhm</i>			<i>R2k</i>	<i>/2K</i>					
<b>5 kOhm</b>			<b>R5k</b>	<b>/5K</b>					
<b>10 kOhm</b>			<b>R10k</b>	<b>/10k</b>					
<i>Option 20 kOhm</i>			<i>R20K</i>	<i>/20k</i>					
<i>Option rear shaft:</i>									
<i>Standard Ø6.00 x 20 mm</i>							<i>RA</i>		
<i>Shaft length in mm</i>							<i>RAxx,xx</i>		
<i>Shaft diameter in mm (≤6.35 mm)</i>							<i>RADMx,xx</i>		
<b>Resistance tolerance:</b>									
<b>±3%</b>							<b>W3%</b>		
<i>Option ±1%</i>							<i>W1%</i>		
<b>Independent linearity:</b>									
<b>±0.50%</b>								<b>L0,5%</b>	
<i>Option ±0.35% R ≤ 1kOhm</i>								<i>L0,35%</i>	
<i>Option ±0.25% R &gt; 1kOhm</i>								<i>L0,25%</i>	
<i>Option center tap:</i>								<i>CT</i>	
<b>Front shaft:</b>									
<b>Standard Ø6.00 x 22 mm</b>								-	
<i>Option Ø6.35 x 22 mm</i>								<i>DM6,35</i>	
<i>Option shaft length in mm</i>								<i>Ax,xx</i>	
<i>Option shaft diameter in mm (≤6.35 mm)</i>								<i>DMx,xx</i>	
<i>Option screwdriver slot:</i>									<i>B</i>
<b>Shaft sealing:</b>									
<b>Standard is without sealing</b>									-
<i>Option D with shaft sealing</i>									<i>D</i>

**For higher quantities or on-going demand, additional options are available as described below on request**

For Example: Multi ganged potentiometers (max. 10), sealed housing case, special electrical and mechanical angles of rotation, and special resistance and linearity tolerances. Furthermore we can mount gear wheels or attach cable assemblies with or without connectors and much more.

# Data Sheet for Precision Potentiometer



Singleturn Wirewound Potentiometer

Series RP19/20

## Drawing

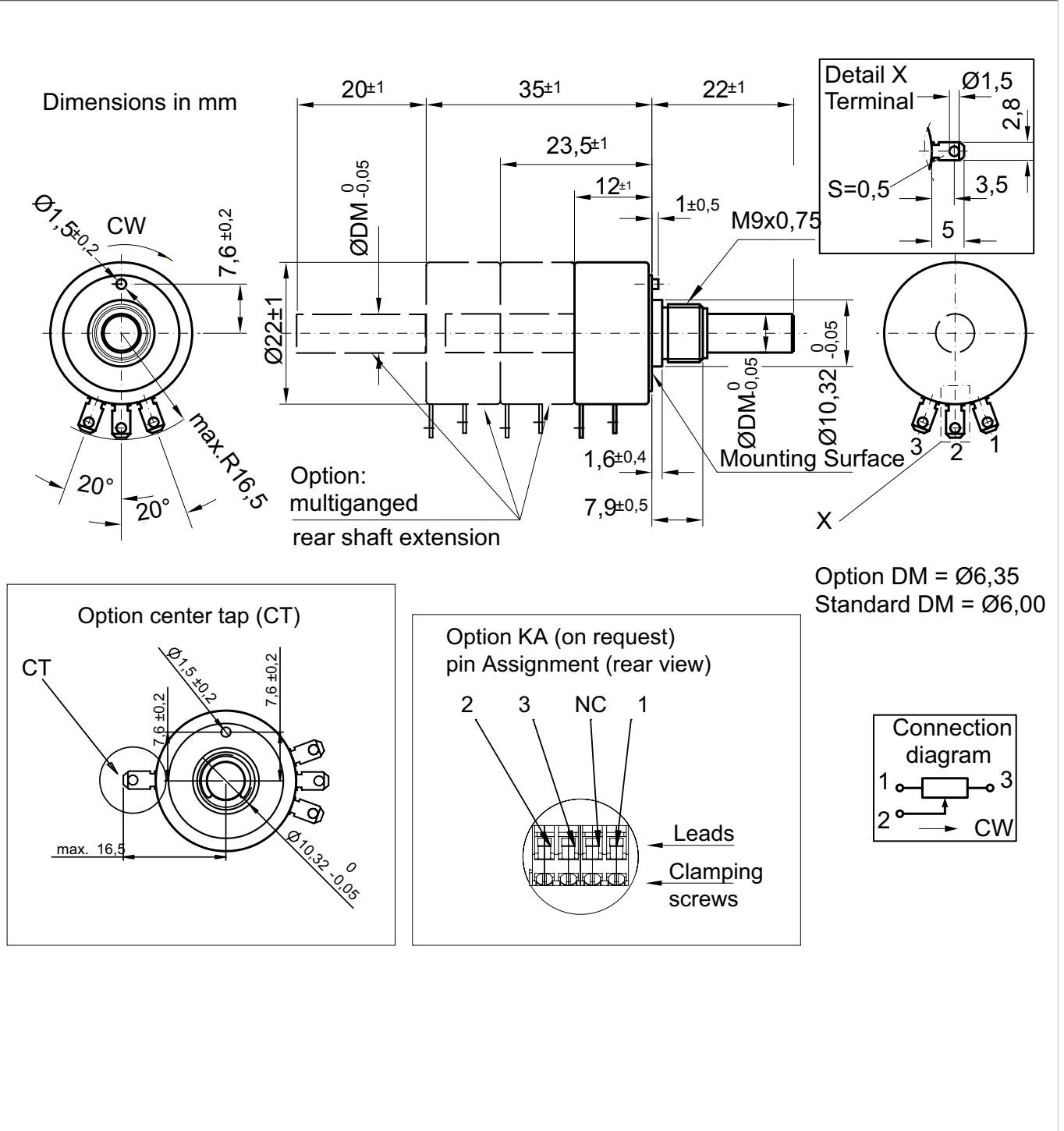

### On Request: Special machining on shaft

Slot

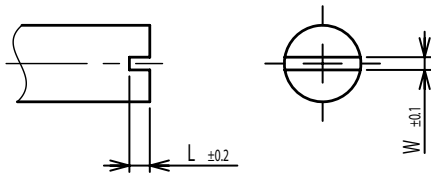

Groove

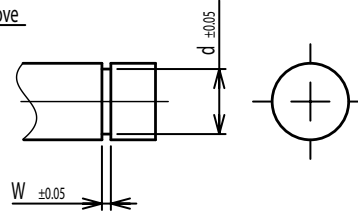

Flat

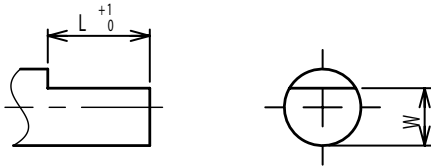

Round top

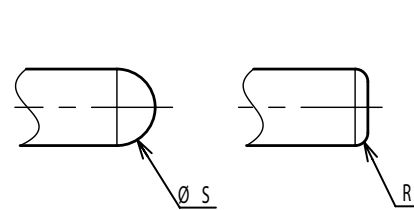

Double side flat

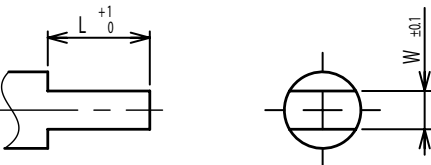

Counterbore hole

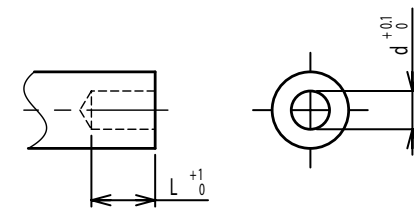

Step

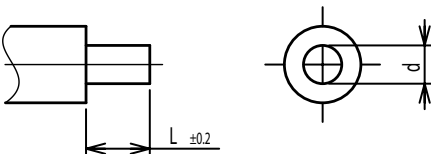

Counterbore screw hole

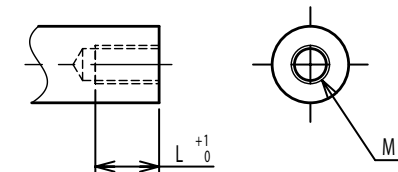

Screw Thread

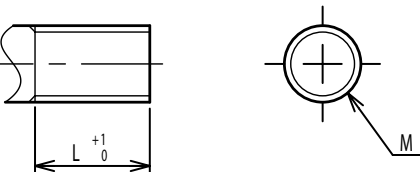

Pin hole

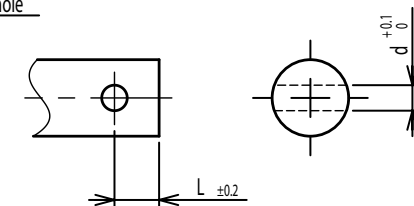

Knurled(Parallel)

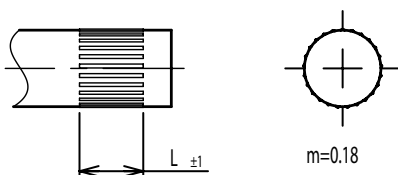

Screw thread inside hole

