

Data Sheet for Precision Potentiometer

Conductive Plastic Potentiometer

Series MPS20



The MPS20 potentiometers in 22 mm housing are for applications where precise, long-lasting and compact sensors with servo flange and radial connections are important.

- Long life span and accuracy
- Servo flange and radial connections
- Compact sensor with low installation depth 18 mm

The conductive plastic potentiometer MP20 is a multi-talent which is adaptable for a wide range of applications.

Electrical Data

Effective electrical angle of rotation 1.)	320° ±5°
Total resistance 1.)	0.5 up to 100 kOhm
Resistance tolerance	±15% (±10%)
Independent linearity (best straight line) 1.)	±1% (±0.5%)
Theoretical resolution	Nearly infinite
Backlash (Hysteresis) 1.)	≤ 0,5°
Max. / recommended wiper current 1.)	10 / 2 µA
Power rating @ 70°C (0W @ 105°C)	1 W
Insulation Voltage 1.)	500 VAC, 1min
Insulation Resistance 1.)	1000 MOhm @ 500 VDC

Mechanical Data, Environmental Conditions, Miscellaneous

Mechanical angle of rotation 1.)	360° without stop
Lifetime (90% el. eff. angle half sine) 2.)	10 Mio. rotations
Max. operational speed	400 rev. / min.
Bearing	2 x ball bearing
Operational torque @ ambient temperature 1.) 2.)	5 Nmm
Operating temperature range	-55°C up to +105°C
Storage temperature range	-55°C up to +105°C
Protection grade (IEC 60529)	IP40
Vibration (IEC 68-2-6, Test Fc)	15g 10Hz to 2000Hz x 12h
Shock (IEC 68-2-27, Test Ea)	49g @ 11 ms x 18
Housing diameter	22 mm
Housing depth	18 mm
Shaft diameter	6.00 mm (optional 6.35 mm)
Shaft type	Solid shaft

Data Sheet for Precision Potentiometer

Conductive Plastic Potentiometer

Series MPS20

Mechanical Data, Environmental Conditions, Miscellaneous

Max. radial load	≤1 N
Max. axial load	≤1 N
Connection type	Gold plated soldering lugs
Connection position	Radial
Sensor mounting	Servo flange
Mass	22 g
Fastening parts included in delivery	Servo clamps with screw 3 x M3x0.5
Material shaft	Stainless steel
Material housing	Reinforced fibreglass PA66

1.) According IEC 60393

2.) Determined by climatic conditions according to IEC 68-1, para. 5.3.1 without load collectives

Please note: Max. permissible supply voltage <75 VDC respectively <50 VAC in addition the max. power rating must be observed

Data Sheet for Precision Potentiometer

Conductive Plastic Potentiometer

Series MPS20

Order code

Description	Selection: standard=black/bold , possible <i>options=grey/italic</i>					
Series	MPS20					
Resistance value: <i>Option 500 Ohm</i>		<i>R500</i>				
1 kOhm <i>Option 2 kOhm</i>		R1k <i>R2k</i>				
5 kOhm 10 kOhm <i>Option 20 kOhm</i>		R5k R10k <i>R20K</i>				
<i>Option 50 kOhm</i> <i>Option 100 kOhm</i>		<i>R50K</i> <i>R100K</i>				
Resistance tolerance: ±15% <i>Option ±10%</i>			W15% <i>W10%</i>			
Independent linearity: ±1% <i>Option ±0.5%</i>				L1% <i>L0,5%</i>		
<i>Option center tap:</i>					<i>CT</i>	
Front shaft: Standard Ø6.00 x 11.5 mm <i>Option Ø6.35 x 11.5 mm</i> <i>Option shaft length in mm</i> <i>Option shaft diameter in mm (≤6.35 mm)</i>						- <i>DM6,35</i> <i>Ax,xx</i> <i>DMx,xx</i>

For higher quantities or on-going demand, additional options are available as described below on request

For Example: Multi ganged potentiometers, with mech. stop, sealed housing case, special electrical and mechanical angles of rotation, and special resistance and linearity tolerances. Furthermore we can mount gear wheels or attach cable assemblies with or without connectors and much more.

Data Sheet for Precision Potentiometer

Conductive Plastic Potentiometer

Series MPS20

Drawing

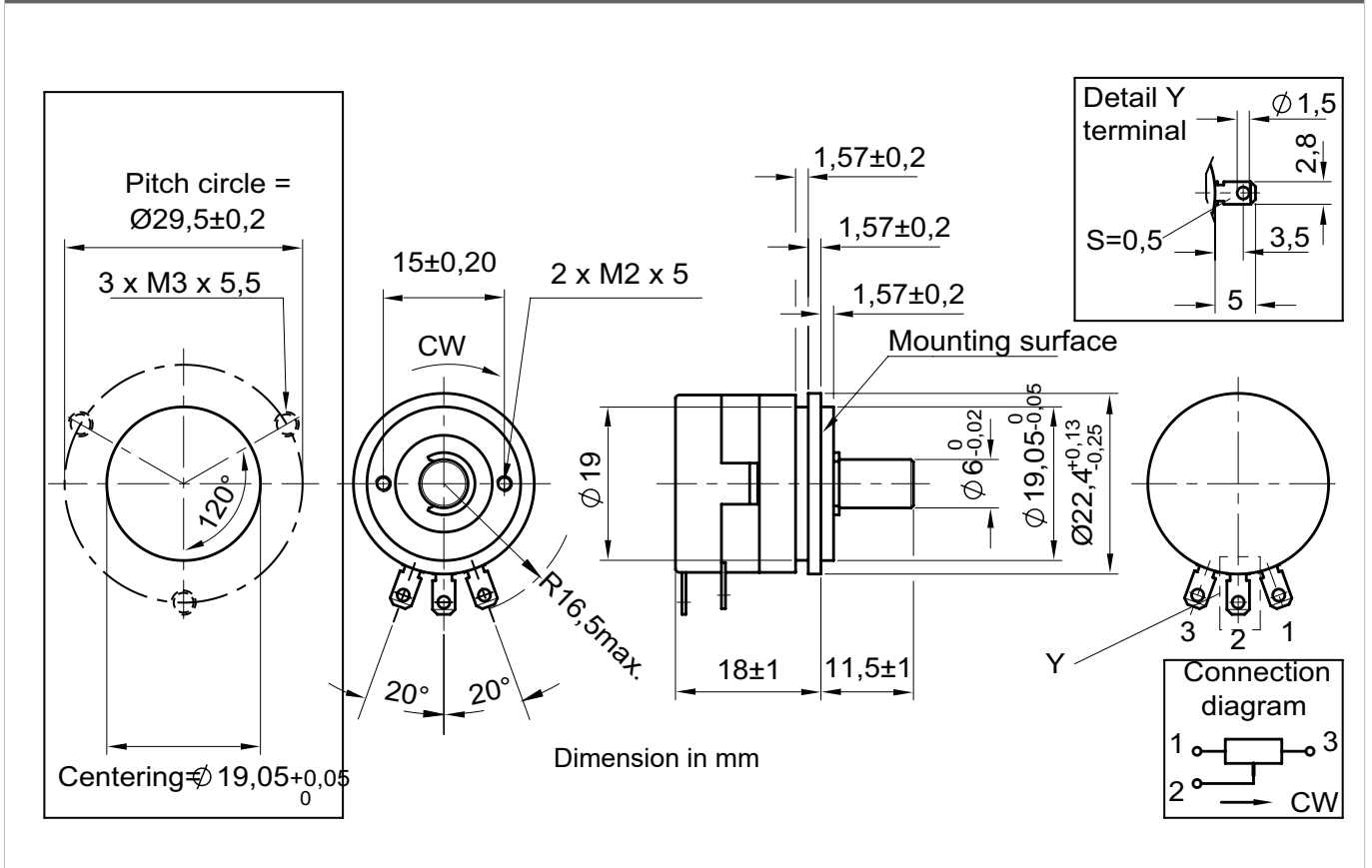

On Request: Special machining on shaft

Slot

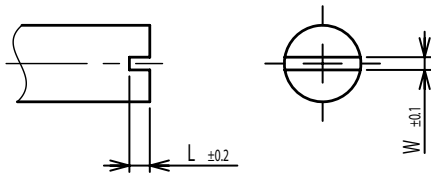

Groove

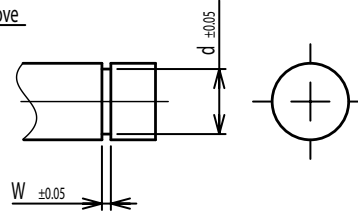

Flat

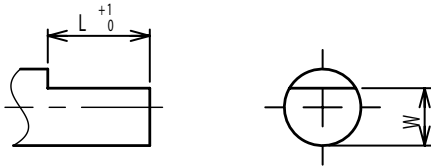

Round top

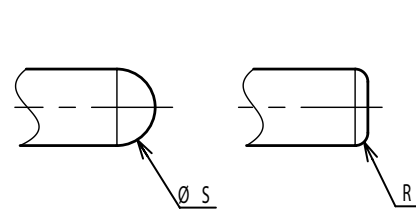

Double side flat

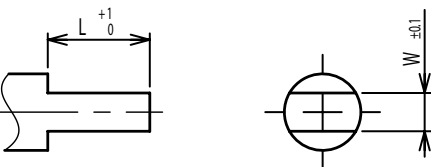

Counterbore hole

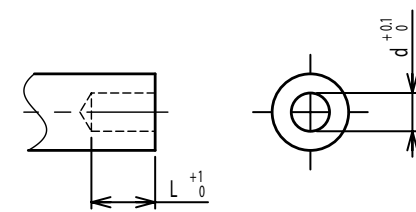

Step

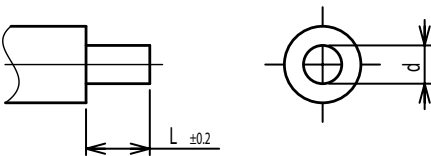

Counterbore screw hole

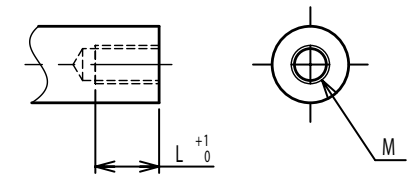

Screw Thread

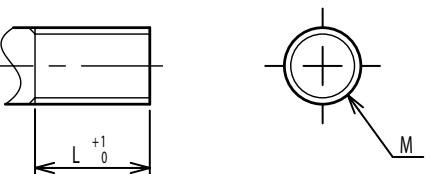

Pin hole

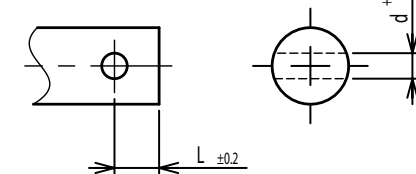

Knurled(Parallel)

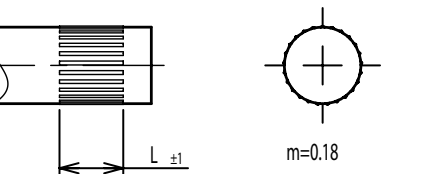

Screw thread inside hole

